



BASIC UNIT SIMOCODE PRO S; PROFIBUS DP INTERFACE 1.5 MBIT/S; 4I/2O FREELY PARAMETERIZABLE; US: DC 24V; INPUT F. THERMISTOR CONNECTION; MONOSTABLE RELAY OUTPUTS EXPANDABLE BY ONE EXPANSION MODULE

Figure similar

product brand name	SIRIUS
Product designation	SIMOCODE pro S Motor Management System
Design of the product	Basic device 0

General technical data:	
Active power loss total typical	5 W
Insulation voltage	
• with degree of pollution 3 Rated value	300 V
• Rated value	300 V
Shock resistance	
• acc. to IEC 60068-2-27	15g / 11 ms
Vibration resistance	1-6 Hz / 15 mm; 6-500 Hz / 2 g
Surge voltage resistance Rated value	4 000 V
Mechanical service life (switching cycles)	
• typical	10 000 000
Electrical endurance (switching cycles)	
• typical	100 000
Protection class IP	IP20
Equipment marking	
• acc. to DIN EN 61346-2	F
• acc. to DIN EN 81346-2	F

Electromagnetic compatibility:	
EMC emitted interference	
• acc. to IEC 60947-1	class A
EMI immunity acc. to IEC 60947-1	corresponds to degree of severity 3

Conducted interference due to burst acc. to IEC 61000-4-4	2 kV (power ports) / 1 kV (signal ports)
Conducted interference due to conductor-earth surge acc. to IEC 61000-4-5	2 kV
Conducted interference due to conductor-conductor surge acc. to IEC 61000-4-5	1 kV
Conducted interference due to high-frequency radiation acc. to IEC 61000-4-6	10 V
Field-bound parasitic coupling acc. to IEC 61000-4-3	10 V/m
Electrostatic discharge acc. to IEC 61000-4-2	6 kV contact discharge / 8 kV air discharge

#### Inputs/ Outputs:

<b>Number of inputs</b>	4
• for thermistor connection	1
<b>Number of digital inputs</b>	
• with a common reference potential	4
<b>Digital input version</b>	
• Type 1 acc. to IEC 61131	Yes
<b>Number of outputs</b>	2
<b>Number of outputs as contact-affected switching element</b>	2
<b>Number of semiconductor outputs</b>	0

#### Motor protection functions:

<b>Product function overload protection</b>	Yes
<b>Product function Evaluation of thermistor motor protection</b>	Yes

#### Motor control functions:

<b>Product function</b>	
• parameterizable overload relay	Yes
• circuit breaker control	Yes
• direct start	Yes
• reverse starting	Yes
• star-delta circuit	Yes
• star-delta reversing circuit	No
• Dahlander circuit	No
• Dahlander reversing circuit	No
• pole-changing switch circuit	No
• pole-changing switch reversing circuit	No
• Slide control	No
• valve control	No

#### Communication/ Protocol:

<b>Product function Bus communication</b>	Yes
<b>Protocol is supported</b>	

• PROFIBUS DP protocol	Yes
• PROFINET IO protocol	No
• PROFI-safe protocol	No
• LLDP	No
• Address Resolution Protocol (ARP)	No
• SNMP	No
• HTTPS	No
• OPC UA Server	No
• NTP	No
• Media Redundancy Protocol (MRP)	No
<b>Product function</b>	
• web server	No
• shared device	No
• at the Ethernet interface Autonegotiation	No
• at the Ethernet interface Autosensing	No
• MRRT redundancy procedure	No
• is supported PROFINET system redundancy	No
• supports PROFINET energy measured values	No
• supports PROFINET energy shutdown	No
Type of electrical connection of the communication interface	Terminal

Installation/ mounting/ dimensions:	
<b>mounting position</b>	any
<b>Mounting type</b>	screw and snap-on mounting
<b>Height</b>	100 mm
<b>Width</b>	22.5 mm
<b>Depth</b>	124.5 mm

Connections/ Terminals:	
<b>Type of electrical connection</b>	
• for auxiliary and control current circuit	screw-type terminals
<b>Product function</b>	
• removable terminal for auxiliary and control circuit	Yes
<b>Type of connectable conductor cross-section</b>	
• solid	1x (0.5 ... 2.5 mm <sup>2</sup> ), 2x ( 0.5 ... 1.5 mm <sup>2</sup> )
• finely stranded with core end processing	1x (0.5 ... 2.5 mm <sup>2</sup> ), 2x (0.5 ... 1 mm <sup>2</sup> )
• for AWG conductors	
— solid	1x (20 ... 14), 2x (20 ... 16)
<b>Tightening torque</b>	
• with screw-type terminals	0.6 ... 0.8 N·m
<b>Tightening torque [lbf·in]</b>	

- with screw-type terminals

5.2 ... 7 lbf·in

#### Ambient conditions:

<b>Installation altitude at height above sea level maximum</b>	4 000 m
<b>Ambient temperature</b>	
<ul style="list-style-type: none"> <li>• during operation</li> </ul>	-25 ... +60 °C
<ul style="list-style-type: none"> <li>• during storage</li> </ul>	-40 ... +80 °C
<ul style="list-style-type: none"> <li>• during transport</li> </ul>	-40 ... +80 °C
<ul style="list-style-type: none"> <li>• at installation altitude ≤ 3000m during operation maximum</li> </ul>	50 °C
<ul style="list-style-type: none"> <li>• at installation altitude ≤ 4000 m during operation maximum</li> </ul>	40 °C
<b>Relative humidity during operation</b>	10 ... 95 %
<b>Contact rating of the auxiliary contacts acc. to UL</b>	B300 / R300

#### Short-circuit:

Design of short-circuit protection per output	Fuse links: gG 6 A, quick-response 10 A (IEC 60947-5-1), miniature circuit-breaker C char.: 1.6 A (IEC 60947-5-1) or 6 A (I_K < 500 A)
-----------------------------------------------	----------------------------------------------------------------------------------------------------------------------------------------

#### Safety related data:

<b>Protection against electrical shock</b>	finger-safe
--------------------------------------------	-------------

#### Galvanic isolation:

<b>Design of the electrical isolation</b>	Protective separation in accordance with IEC 60947-1 for all circuits
<ul style="list-style-type: none"> <li>• Note</li> </ul>	Test report no. 2668 is to be observed

#### Main circuit:

<b>Operating voltage</b>	
<ul style="list-style-type: none"> <li>• for DC Rated value</li> </ul>	
— maximum	24 V
— minimum	24 V





#### Control circuit/ Control:





<b>Type of voltage of the control supply voltage</b>	DC
<b>Control supply voltage for DC</b>	
<ul style="list-style-type: none"> <li>• Rated value</li> </ul>	24 ... 24 V
<b>Control supply voltage 1</b>	
<ul style="list-style-type: none"> <li>• for DC Rated value</li> </ul>	24 V
<b>Response value of thermoresistor</b>	3 400 ... 3 800 Ω

#### Supply voltage:

<b>Type of voltage of the supply voltage</b>	DC
----------------------------------------------	----

#### Certificates/ approvals:

General Product Approval			For use in hazardous locations	Test Certificates
				<a href="#">Explosion Protection Certificate</a> <a href="#">Special Test Certificate</a>

Test Certificates	Shipping Approval	other		
<a href="#">Type Test Certificates/Test Report</a>	 ABS	 DNV	 GL	<a href="#">Declaration of Conformity</a>  Profibus

### Further information

**Information- and Downloadcenter (Catalogs, Brochures,...)**

<http://www.siemens.com/industrial-controls/catalogs>

**Industry Mall (Online ordering system)**

<http://www.siemens.com/industrymall>

**Cax online generator**

<http://support.automation.siemens.com/WW/CAXorder/default.aspx?lang=en&mfb=3UF70201AB010>

**Service&Support (Manuals, Certificates, Characteristics, FAQs,...)**

<https://support.industry.siemens.com/cs/ww/en/ps/3UF70201AB010>

**Image database (product images, 2D dimension drawings, 3D models, device circuit diagrams, EPLAN macros, ...)**

[http://www.automation.siemens.com/bilddb/cax\\_de.aspx?mfb=3UF70201AB010&lang=en](http://www.automation.siemens.com/bilddb/cax_de.aspx?mfb=3UF70201AB010&lang=en)

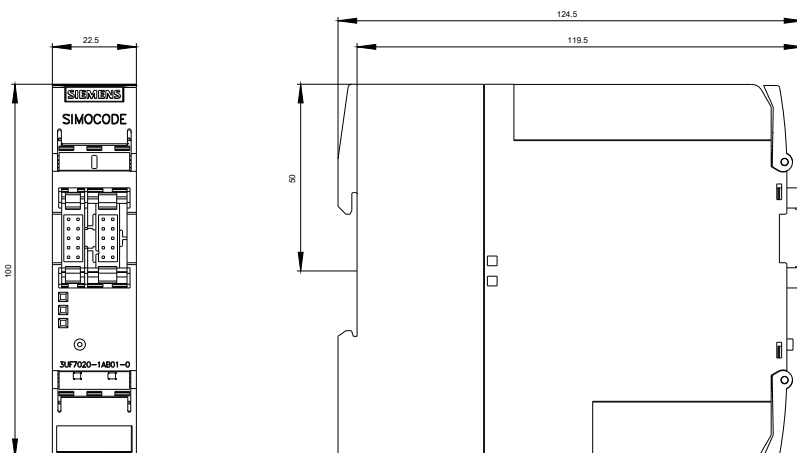

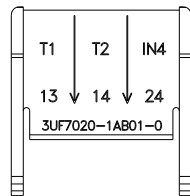
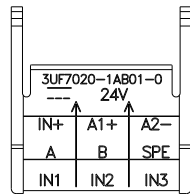
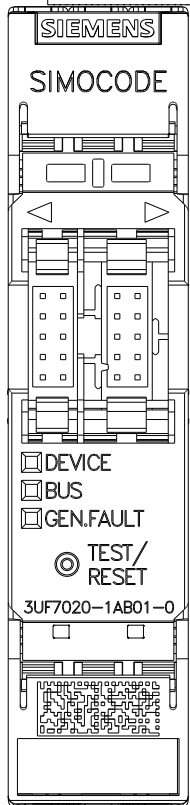
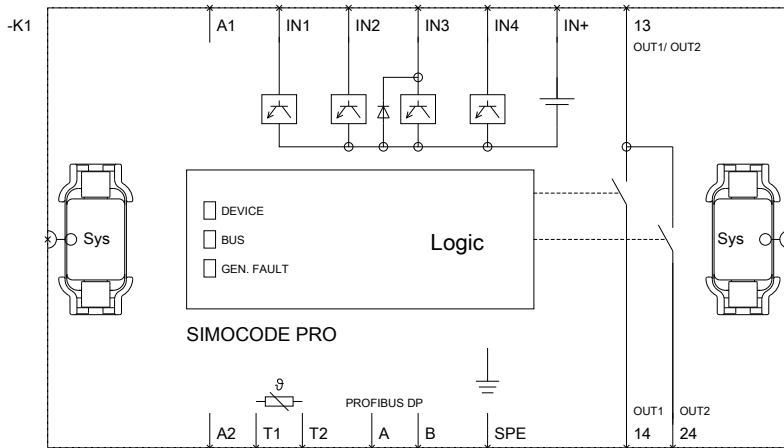

last modified:

23.04.2015